

# TRB141

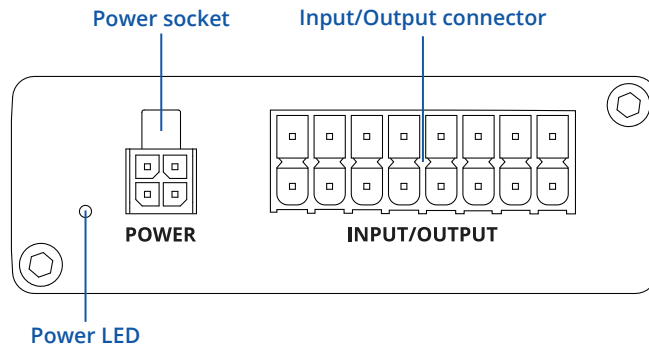

# HARDWARE

## FRONT VIEW



## BACK VIEW

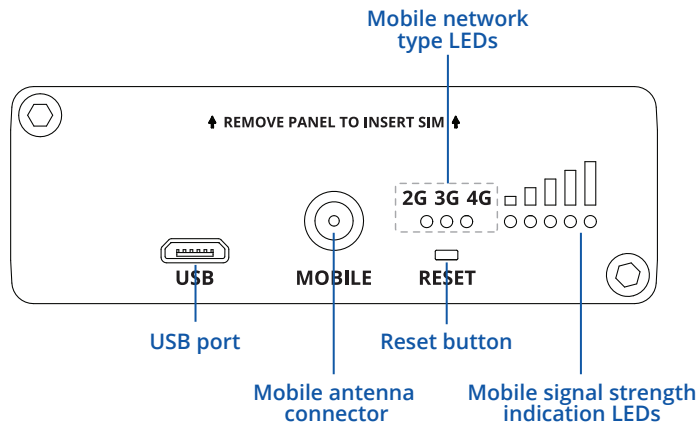

## POWER SOCKET PINOUT

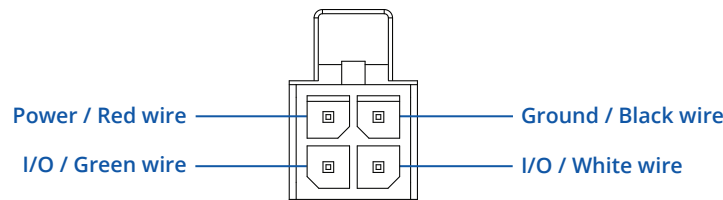

## INPUT/OUTPUT CONNECTOR PINOUT

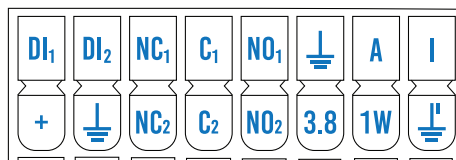

**DI1** and **DI2** are DRY/WET configurable inputs. WET: 0-1.9 V is detected as logical "0", 1.9-3.8 V is detected as logical "1". DRY: Logical "0" is detected when input is shorted to GND, otherwise input is detected as logical "1".

**NC\***, **C\*** and **NO\*** are respectively Normally Closed, Common and Normally Open contacts of internal Relays 1 and 2. Maximum Relay 1 (Non-latching) ratings: 0.5 A at 60 VDC/70 VAC, 1 A at 30 VDC/VAC. Maximum Relay 2 (Latching) ratings: 0.8 A at 70 VDC, 0.9 A at 70 VAC, 2 A at 30 VDC/VAC.

**DI1** and **DI2** are DRY/WET configurable inputs. WET: 0-1.9 V is detected as logical "0", 1.9-3.8 V is detected as logical "1". DRY: Logical "0" is detected when input is shorted to GND, otherwise input is detected as logical "1".

**A** is ADC input. Analog voltage range 0-30 V. Input can be configured for 4-20mA sensor protocol as current measurement of 0-30 mA.

**I** and **↓** are isolated input contacts. 0-7.3 V is detected as logical "0", 7.3-71 V is detected as logical "1".

**I/O** pins: programmable Input/Output pins (Open Collector output, max 30 V or Digital input where 0-7.3 V is detected as logical "0", 7.3-30 V is detected as logical "1").

**+** is power output connected directly to gateway's power supply input pin. This Output can be used for powering external 4-20 mA current sensor.

**3.8** is 3.8V power output which can be used to power 1-Wire sensors when needed.

**1W** 1-Wire protocol input/output.

**Power** pin: +9 ... +30 VDC positive power input..

**Ground** pin: negative/ground connection from power supply.

**↓** is GND contact.

## FEATURES

### MOBILE

Mobile module	4G (LTE) – Cat 1 up to 10 Mbps, 3G – Up to 42 Mbps, 2G – Up to 236.8 kbps
Status	Signal strength (RSSI), SINR, RSRP, RSRQ, EC/IO, RSCP, Bytes sent/received, connected band, IMSI, ICCID
SMS	SMS status, SMS configuration, send/read SMS via HTTP POST/GET, EMAIL to SMS, SMS to EMAIL, SMS to HTTP, SMS to SMS, scheduled SMS, SMS autoreply, SMPP
USSD	Supports sending and reading Unstructured Supplementary Service Data messages
Black/White list	Operator black/white list
Multiple PDN	Possibility to use different PDNs for multiple network access and services
Band management	Band lock, Used band status display
APN	Auto APN
Bridge	Direct connection (bridge) between mobile ISP and device on LAN
Passthrough	outer assigns its mobile WAN IP address to another device on LAN

### NETWORK

Routing	Static routing
Network protocols	TCP, UDP, IPv4, IPv6, ICMP, NTP, DNS, HTTP, HTTPS, FTP, SMTP, SSL v3, TLS, ARP, VRRP, PPP, PPPoE, UPNP, SSH, DHCP, Telnet, SMPP, SNMP, MQTT
VoIP passthrough support	H.323 and SIP-alg protocol NAT helpers, allowing proper routing of VoIP packets
Connection monitoring	Ping Reboot, Wget Reboot, Periodic Reboot, LCP and ICMP for link inspection
Firewall	Port forward, traffic rules, custom rules
DHCP	Static and dynamic IP allocation, DHCP Relay
QoS / Smart Queue Management (SQM)	Traffic priority queuing by source/destination, service, protocol or port, WMM, 802.11e
DDNS	Supported >25 service providers, others can be configured manually
Network backup	Mobile, VRRP, Wired options, each of which can be used as an automatic Failover
SSHFS	Possibility to mount remote file system via SSH protocol

### SECURITY

Authentication	Pre-shared key, digital certificates, X.509 certificates, TACACS+, Radius, IP & Login attempts block
Firewall	Pre-configured firewall rules can be enabled via WebUI, unlimited firewall configuration via CLI; DMZ; NAT; NAT-T
Attack prevention	DDOS prevention (SYN flood protection, SSH attack prevention, HTTP/HTTPS attack prevention), port scan prevention (SYN-FIN, SYN-RST, X-mas, NULL flags, FIN scan attacks)
VLAN	Port and tag-based VLAN separation
Mobile quota control	Mobile data limit, customizable period, start time, warning limit, phone number
WEB filter	Blacklist for blocking out unwanted websites, Whitelist for specifying allowed sites only
Access control	Flexible access control of TCP, UDP, ICMP packets, MAC address filter

### VPN

OpenVPN	Multiple clients and a server can run simultaneously, 27 encryption methods
OpenVPN Encryption	DES-CBC 64, RC2-CBC 128, DES-EDE-CBC 128, DES-EDE3-CBC 192, DESX-CBC 192, BF-CBC 128, RC2-40-CBC 40, CAST5-CBC 128, RC2-64-CBC 64, AES-128-CBC 128, AES-128-CFB 128, AES-128-CFB1 128, AES-128-CFB8 128, AES-128-OFB 128, AES-128-GCM 128, AES-192-CFB 192, AES-192-CFB1 192, AES-192-CFB8 192, AES-192-OFB 192, AES-192-CBC 192, AES-192-GCM 192, AES-256-GCM 256, AES-256-CFB 256, AES-256-CFB1 256, AES-256-CFB8 256, AES-256-OFB 256, AES-256-CBC 256
IPsec	IKEv1, IKEv2, with 14 encryption methods for IPsec (3DES, DES, AES128, AES192, AES256, AES128GCM8, AES192GCM8, AES256GCM8, AES128GCM12, AES192GCM12, AES256GCM12, AES128GCM16, AES192GCM16, AES256GCM16)
GRE	GRE tunnel, GRE tunnel over IPsec support
PPTP, L2TP	Client/Server instances can run simultaneously, L2TPv3, L2TP over IPsec support
Stunnel	Proxy designed to add TLS encryption functionality to existing clients and servers without any changes in the program's code
DMVPN	Method of building scalable IPsec VPNs
SSTP	SSTP client instance support
ZeroTier	ZeroTier VPN client support
WireGuard	WireGuard VPN client and server support
Tinc	Tinc offers encryption, authentication and compression in it's tunnels. Client and server support

### MODBUS TCP SLAVE

ID range	Respond to one ID in range [1;255] or any
Allow Remote Access	Allow access through WAN
Custom registers	MODBUS TCP custom register block requests, which read/write to a file inside the router, and can be used to extend MODBUS TCP Slave functionality

### MODBUS TCP MASTER

Supported functions	01, 02, 03, 04, 05, 06, 15, 16
Supported data formats	8-bit: INT, UINT; 16-bit: INT, UINT (MSB or LSB first); 32-bit: float, INT, UINT (ABCD (big-endian), DCBA (little-endian), CDAB, BADC)

### DATA TO SERVER

Protocol	HTTP(S), MQTT, Azure MQTT, Kinesis
----------	------------------------------------

### MQTT GATEWAY

MQTT Gateway	Allows sending commands and receiving data from MODBUS Master through MQTT broker
--------------	---

### DNP3

Supported modes	TCP Master, DNP3 Outstation
-----------------	-----------------------------

### MONITORING & MANAGEMENT

WEB UI	HTTP/HTTPS, status, configuration, FW update, CLI, troubleshoot, event log, system log, kernel log
FOTA	Firmware update from server, automatic notification
SSH	SSH (v1, v2)
SMS	SMS status, SMS configuration, send/read SMS via HTTP POST/GET
Call	Reboot, Status, Mobile data on/off, Output on/off, answer/hang-up with a timer
TR-069	OpenACS, EasyCwmp, ACSLite, tGem, LibreACS, GenieACS, FreeACS, LibCWMP, Friendly tech, AVSystem
MQTT	MQTT Broker, MQTT publisher
SNMP	SNMP (v1, v2, v3), SNMP Trap
JSON-RPC	Management API over HTTP/HTTPS
MODBUS	MODBUS TCP status/control
RMS	Teltonika Remote Management System (RMS)

### IOT PLATFORMS

Cloud of Things	Allows monitoring of: Device data, Mobile data, Network info, Availability
ThingWorx	Allows monitoring of: WAN Type, WAN IP, Mobile Operator Name, Mobile Signal Strength, Mobile Network Type
Cumulocity	Allows monitoring of: Device Model, Revision and Serial Number, WAN Type and IP, Mobile Cell ID, ICCID, IMEI, Connection Type, Operator, Signal Strength
Azure IoT Hub	Can send device IP, Number of bytes send/received, Temperature, PIN count to Azure IoT Hub server, Mobile connection state, Network link state, IMEI, ICCID, Model, Manufacturer, Serial, Revision, IMSI, SIM State, PIN state, GSM signal, WCDMA RSCP, WCDMA EC/IO, LTE RSRP, LTE SINR, LTE RSRQ, CELL ID, Operator, Operator number, Connection type

### SYSTEM CHARACTERISTICS

CPU	ARM Cortex-A7 1.2 GHz
RAM	128 MB, DDR2
FLASH storage	512 MB, SPI Flash

### FIRMWARE / CONFIGURATION

WEB UI	Update FW from file, check FW on server, configuration profiles, configuration backup
FOTA	Update FW
RMS	Update FW/configuration for multiple devices at once
Keep settings	Update FW without losing current configuration

### FIRMWARE CUSTOMIZATION

Operating system	RutOS (OpenWrt based Linux OS)
Supported languages	Busybox shell, Lua, C, C++
Development tools	SDK package with build environment provided

## INPUT / OUTPUT

Input	2 x Digital inputs (configurable passive or active), 1 x Isolated input, 1 x Analog input ( with 4-20 mA capability). 1 x Configurable Inputs. Digital input 0 - 5 V detected as logic low, 8 - 30 V detected as logic high
Output	2 x Relay outputs (latching and non latching). 1 x Configurable Output, Open collector output, max output 30 V, 300 mA
Events	Email, RMS, SMS
I/O juggler	Allows to set certain I/O conditions to initiate event

## POWER

Connector	4-pin industrial DC power socket
Input voltage range	9 – 30 VDC, reverse polarity protection; surge protection >31 VDC 10us max
Power consumption	< 5 W

## PHYSICAL INTERFACES

I/O's	3 x Digital Inputs, 1 x Analog input, 2 x Relays on 16 pin connector, 2 x I/O pins on 4 pin power connector
Status LEDs	3 x connection type status LEDs, 5 x connection strength LEDs, 1 x Power LED
SIM	1 x SIM slot (Mini SIM – 2FF), 1.8 V/3 V
Power	1 x 4-pin power connector
1-Wire	1 x 1-Wire interface on 16 pin connector
Antennas	1 x SMA for LTE
USB	1 x Virtual network interface via micro USB
Reset	Reboot/User default reset/Factory reset button

## PHYSICAL SPECIFICATION

Casing material	Aluminum housing
Dimensions (W x H x D)	74.5 x 25 x 64.4 mm
Weight	136 g
Mounting options	Bottom and sideways DIN rail, Flat surface

## OPERATING ENVIRONMENT

Operating temperature	-40 °C to 75 °C
Operating humidity	10% to 90% non-condensing
Ingress Protection Rating	IP30

## REGULATORY & TYPE APPROVALS

Regulatory	CE/RED, EAC, RoHS, WEEE
------------	-------------------------

## EMC EMISSIONS & IMMUNITY

Standards	Draft ETSI EN 301 489-1 V2.2.0, Draft EN 301 489-19 V2.1.0, Draft ETSI EN 301 489-52 V1.1.0
ESD	EN 61000-4-2:2009
RS	EN 61000-4-3:2006 + A1:2008 + A2:2010
EFT	EN 61000-4-4:2012
Surge protection	EN 61000-4-5:2014
CS	EN 61000-4-6:2014
DIP	EN 61000-4-11:2004

## RF

Standards	EN 300 511 V12.5.1, ETSI EN 301 908-1 V11.1.1, ETSI EN 301 908-2 V11.1.2, ETSI EN 301 908-13 V11.1.2
-----------	--







## SAFETY

Standards	IEC 62368-1:2014(Second Edition), EN 62368-1:2014+A11:2017 EN 50385:2017 EN 62232:2017
-----------	--

## WHAT'S IN THE BOX?

### STANDARD PACKAGE CONTAINS\*

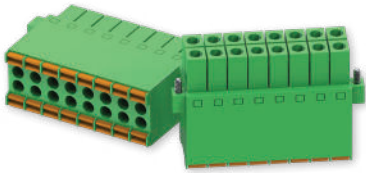
- TRB141 Gateway
- 9 W PSU
- 1x LTE antenna (magnetic mount, SMA male, 3 m cable)
- Micro-USB cable (0.8 m)
- 1x hex key
- I/O connector
- QSG (Quick Start Guide)
- Packaging box

 <p><b>TRB141 GATEWAY</b></p>	 <p><b>9 W PSU</b></p>	 <p><b>1X LTE ANTENNA (MAGNETIC MOUNT, SMA MALE, 3 M)</b></p>
 <p><b>MICRO-USB CABLE (0.8 M)</b></p>	 <p><b>1X HEX KEY</b></p>	 <p><b>I/O CONNECTOR</b></p>
 <p><b>QSG</b></p>		

\* For all standard order codes standard package contents are the same, except for PSU.

## STANDARD ORDER CODES

PRODUCT CODE	HS CODE	HTS CODE	PACKAGE CONTAINS
TRB141 003000	851762	8517.62.00	Standard Package with EU PSU
TRB141 106000	851762	8517.62.00	Standard Package with AU PSU
TRB141 40A300	851762	8517.62.00	Standard Package with JP PSU

For more information on all available packaging options – please contact us directly.

## AVAILABLE VERSIONS

PRODUCT CODE	REGION (OPERATOR)	FREQUENCY
TRB141 0*****	Europe <sup>1</sup> , The Middle East, Africa, Korea, Thailand, India	<ul style="list-style-type: none"> <li>• <b>4G (LTE-FDD):</b> B1, B3, B7, B8, B20, B28A</li> <li>• <b>3G:</b> B1, B8</li> <li>• <b>2G:</b> B3, B8</li> </ul>
TRB141 1*****	South America, Australia, New Zealand, Taiwan	<ul style="list-style-type: none"> <li>• <b>4G (LTE-FDD):</b> B1, B2<sup>2</sup>, B3, B4, B5, B7, B8, B28</li> <li>• <b>4G (LTE-TDD):</b> B40</li> <li>• <b>3G:</b> B1, B2, B5, B8</li> <li>• <b>2G:</b> B2, B3, B5, B8</li> </ul>
TRB141 4*****	Japan	<ul style="list-style-type: none"> <li>• <b>4G (LTE-FDD):</b> B1, B3, B8, B18, B19, B26</li> </ul>

The price and lead-times for region (operator) specific versions may vary. For more information please contact us.

\* - Other region versions under development.  
 \*\* - For more detailed information, visit our Wiki.  
 1 - Regional availability - excluding Russia & Belarus.  
 2 - LTE-FDD B2 does not support Rx-diversity.

# TRB141 SPATIAL MEASUREMENTS & WEIGHT

## MAIN MEASUREMENTS

W x H x D dimensions for TRB141

Device housing\*: 74.5 x 25 x 64.4 mm

Box: 173 x 71 x 148 mm

\*Housing measurements are presented without antenna connectors and screws; for measurements of other device elements look to the sections below.

## TOP VIEW

The figure below depicts the measurements of TRB141 and its components as seen from the top:

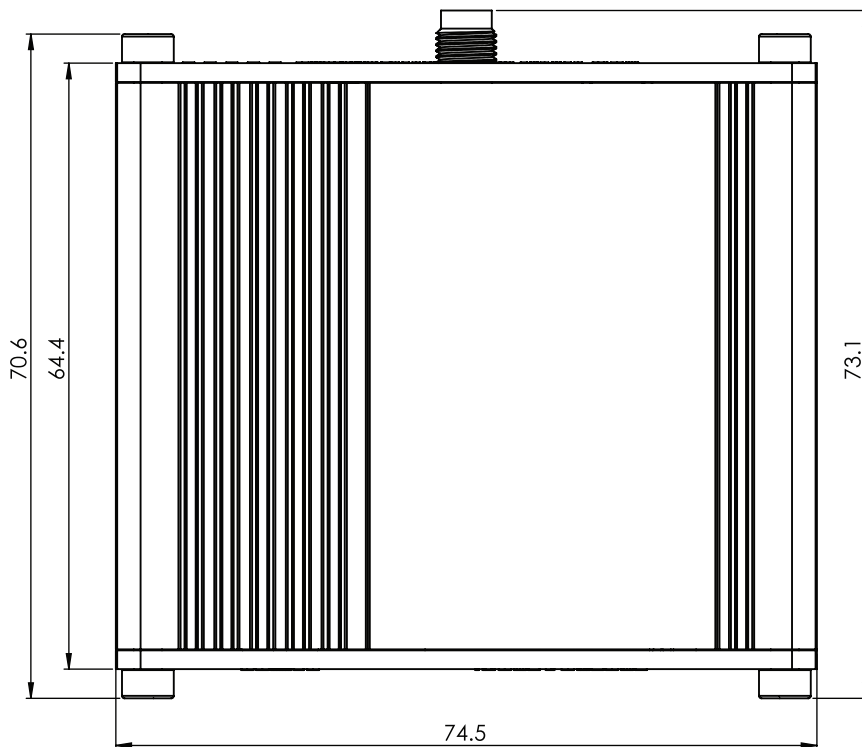

## RIGHT VIEW

The figure below depicts the measurements of TRB141 and its components as seen from the right side:

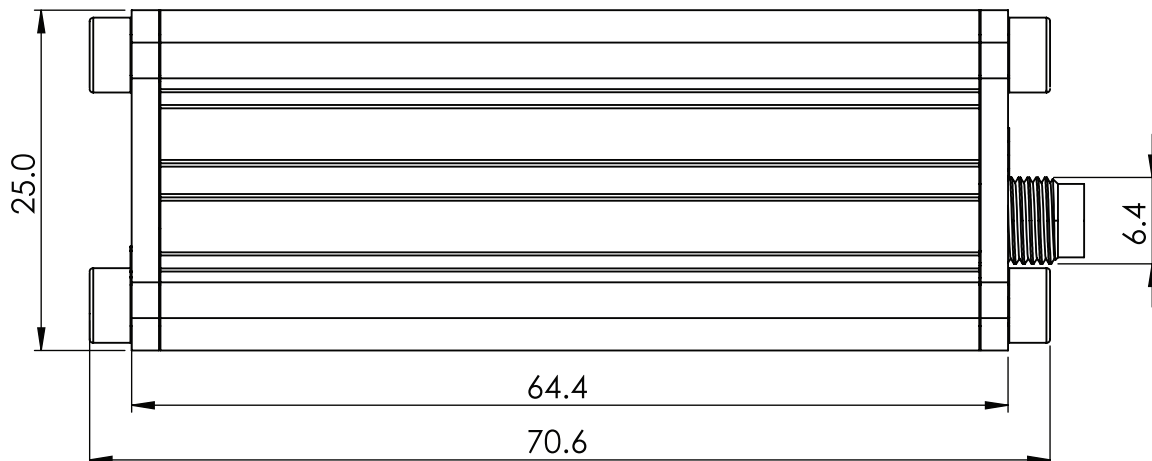



FRONT VIEW

The figure below depicts the measurements of TRB141 and its components as seen from the front:

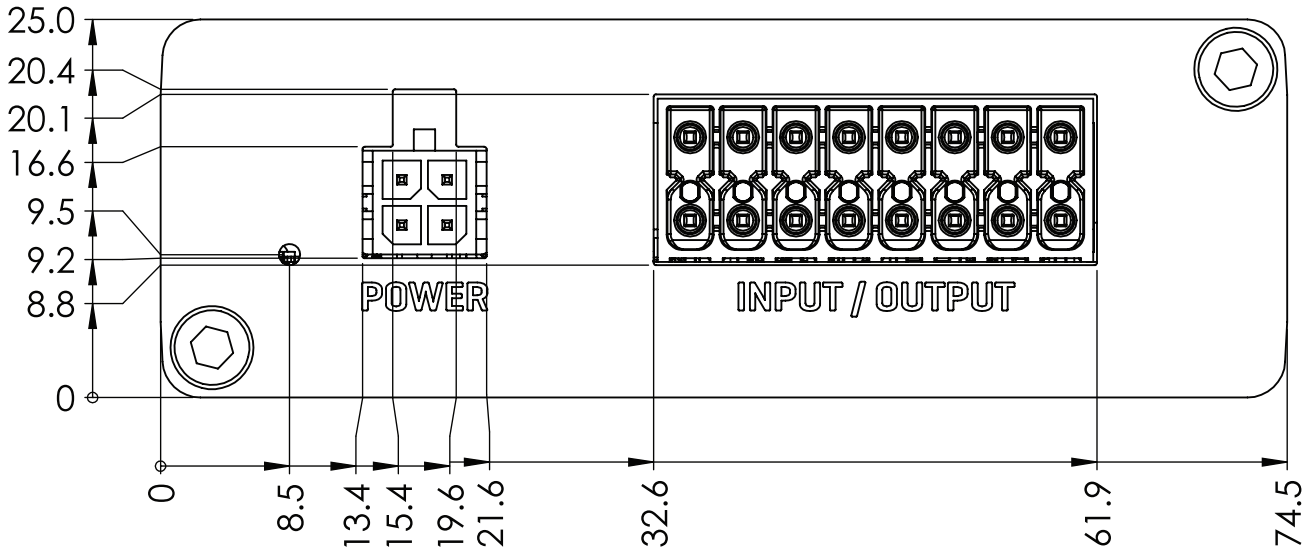

REAR VIEW

The figure below depicts the measurements of TRB141 and its components as seen from the back:

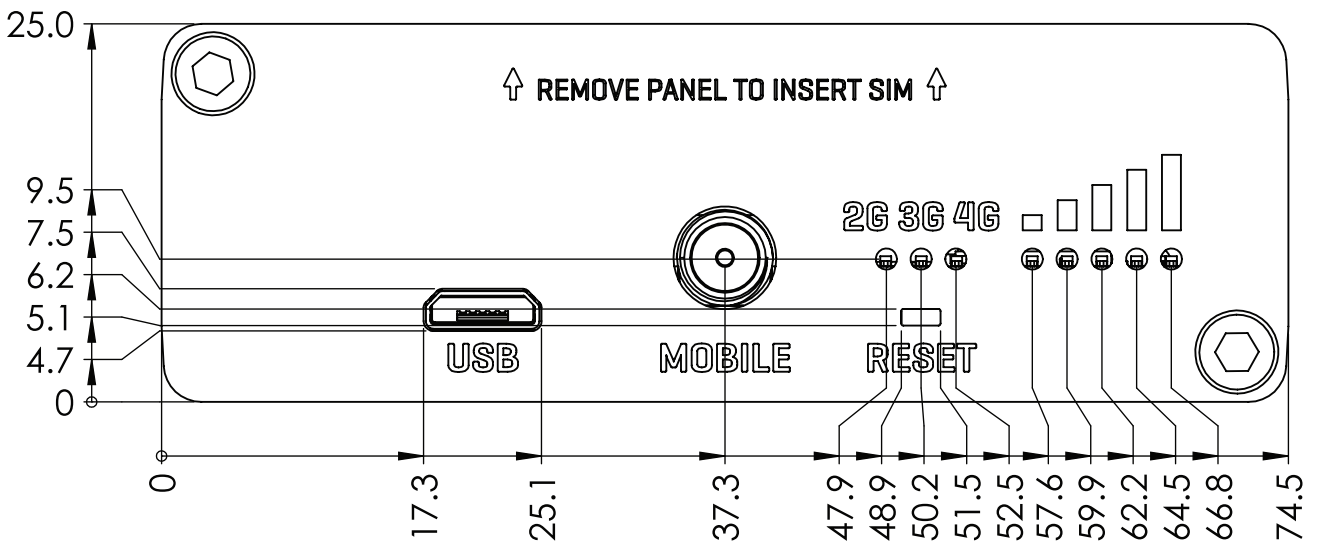

**MOUNTING SPACE REQUIREMENTS**

The figure below depicts an approximation of the device's dimensions when cables and antennas are attached:

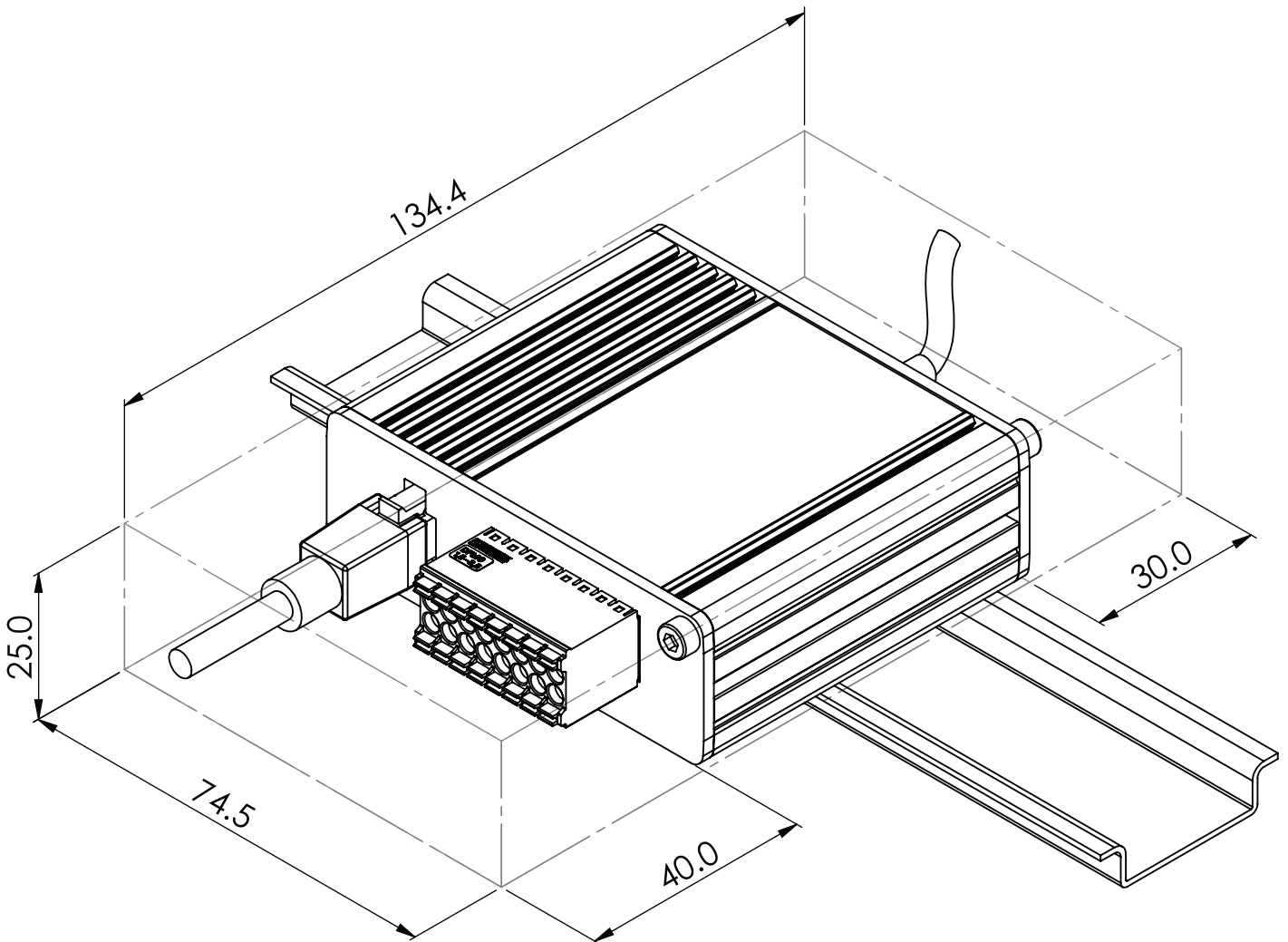

DIN RAIL

The scheme below depicts protrusion measurements of an attached DIN Rail:

