



CommBox Display 43-98 4K User Manual

Version: 2

commBOX
Display

Contents



Features	1
Safety Warning and Precautions	1
Installation and Connection	3
Packing List.....	3
Ports.....	4
Connection Diagram.....	5
Control Buttons on the Panel.....	5
Remote Control	6
Basic Operations	8
Power On/Standby.....	8
No Signal Background.....	8
Source Selection.....	8
Settings Menu.....	8
Instructions	11
Basic Android Operations.....	11
File App.....	12
Important Statement about Network Service	13
Troubleshooting	14
Toxic/Hazardous Substances/Elements in the Product	15



Features

1. This product runs on Android 8.0 operating system with a unique User Interface design, offering you more convenient operation and better visual experience.
2. You can download a huge selection of applications ranging from chats and searches, to learning, shopping and reading over the Internet, with support for simultaneous use of e-mail.
3. This product can be conveniently operated with a mouse and a keyboard with USB ports, just like in the case of a personal computer.
4. Large-capacity memory and buffer enable playing movies and games smoothly.
5. High-quality LCD screen features low radiation, high brightness and high contrast, with a large viewing angle, short response time and no flicker, which greatly reduce eye fatigue and ghosting of fast-moving images.
6. De-interlaced image processing and advanced motion compensation technology greatly improve the jagged and blurred edges of moving images.
7. Dynamic contrast technology significantly improves image definition and contrast.
8. Multiple USB ports support streaming media function.

Safety Warning and Precautions

Thank you for purchasing your high-performance CommBox Display. This product was designed with personal safety in mind and has undergone strict testing before delivery. However, improper installation or use may cause electric shock or fire. To ensure safe use of the product, as well as to maintain its service life and allow for the best performance, please read the operation instructions and labels carefully and observe the following safety precautions before using the product. Please retain this Manual for your future reference.

 Warning	May cause casualties
	Prohibited actions

 Caution	May cause personal injury or property damage
	Imperative operations

In the case of:

- **Power outage or unstable voltage;**
- **Abnormal sound or smell;**
- **Damaged AC power cord;**
- **Product damage caused by a fall, strike or impact;**
- **Any object or liquid falling into the product.**



Turn off the product immediately, disconnect the power plug from the power socket and contact authorised professional service staff for repair.

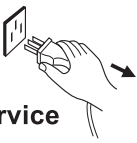

- In case of any flammable gas leakage, do not connect/disconnect the power plug of this product or any other electrical appliance but close the leaky valve and open the doors and windows immediately.

Warning



- Use AC 100-240V, 50/60Hz only.

- Cut off power supply before connecting/disconnecting any cable.

- To avoid the risk of a fall, damage or fire, do not fix the product into any unstable position.

- Do not place the product in any environment:

1. That is too damp, hot, cold, dusty or exposed to direct sunlight;
2. Where flammable or explosive substances are stored or used;
3. Where there are combustible or corrosive gases;
4. Bathroom, kitchen or similar premises.

- Do not use any damaged or inappropriate power outlet. Ensure a good contact between the power plug and outlet.

- Protect the power plug and outlet against dust and metal attachments.

Do not damage the power cord:

1. Do not remodel it;
2. Do not put heavy objects on it;
3. Keep it away from heat sources;
4. Do not pull it when disconnecting the power plug.



- Paralleling multiple power plugs to one power outlet may cause fire due to excessive power consumption.

- To avoid the risk of electric shock and fire, keep the product away from naked flames (like burning candles).

- Do not put any container with water on the product, or the water droplets or splashes could cause electric shock or fire.

- The ventilation holes in the housing are designed to protect the components from overheating and ensure their long-term operation. The product should be placed without blocking such ventilation holes.



- To avoid the risk of electric shock, do not touch the power plug with wet hands.



- In case of storm or lightning, disconnect the power plug and the antenna plug immediately to protect the product against lightning strike.



- To avoid the risk of electric shock and fire, do not disassemble the product in any way. All repairs should be referred to professional technicians.

Caution

- Do not allow children to climb the product.

- To avoid the risk of swallowing or choking, keep small accessories beyond the reach of children.

- Turn off the product and disconnect the power plug before keeping the product idle for a long time for whatever reason.

- Disconnect all cables before changing the position or the angle of the product. To avoid the risk of a fall, move the product slowly.

- Do not use hard objects to rub or strike the screen, or to twist or press it forcibly.

- Disconnect the power plug before cleaning the product with a soft cloth, without using any industrial chemicals. Prevent any foreign object from falling into the product. Improper cleaning may cause damage to the product, erase the printed information or damage the components (if the cleaning fluid or water flows into the product) and cause failure.

- To avoid the risk of condensation or fault, do not use the product immediately after moving it from a low-temperature spot to a higher-temperature spot.

- Cut off the power supply to the product by disconnecting the power plug.

- If the leakage splashes onto your skin in the case when the LCD screen gets broken, rinse the skin with clean water for 15 minutes and seek medical advice.

- When moving the product with your hands, hold the four corners and the bottom side of the panel rather than exerting pressure on the front screen.

- Use the product in a way that promotes health: use it in appropriate lighting conditions; insufficient light or long continuous use may damage your vision.

- The power plug or extension lead may be used to switch off the product in case of emergency.

- Insert the power plug into the power socket properly. A loose connection may cause sparks or fire.

Caution

● If a still image is displayed on the product or there is any still text or icon in a moving image for an extended period of time, a “ghost image” will be left on the screen and remain there long after the product has been turned off. Such fault is not covered by the warranty.

● The technical specifications provided in this Manual and on the packaging are subject to change without further notice. If there is any difference between this Manual and any actual operation, the actual operation shall prevail.

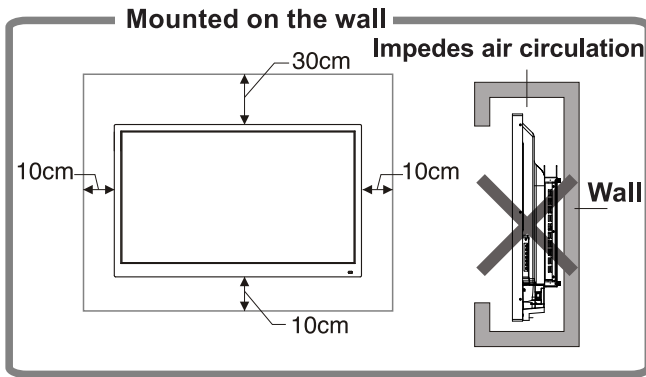

Ventilation

- Maintain the clearance around the product in accordance with the minimum dimensions shown in this image.
- Never cover the ventilation holes or insert any object into the housing.
- Do not place the product in confined space such as in a bookcase or an inbuilt wardrobe unless appropriate ventilation conditions are provided. There should be adequate clearance around the product to ensure proper ventilation.

Installation and Connection

Packing List

Item	
CommBox Display ×1	●
Remote Control ×1	●
User Manual ×1	●
Power Cord ×1	●

Item	
Warranty Card × 1	●
Certificate of Conformity × 1	●
Wall-mount and Instructions × 1	●
Battery × 2	●

Caution:

If you have any problems operating, connecting or troubleshooting the product, please contact us. If the product has any fault, cut off the power supply immediately and contact us. As a Class-A product, it may produce radio interference in living environments. In such case, an extension lead may help control the interference.

Installation Tips

- Install the product near an AC power outlet with easy access.
- For the sake of safety, it is suggested to use a compatible wall-mount bracket or a base for the product.
- To avoid injury, the product must be placed on a stable horizontal surface or affixed to a solid wall.
- Wall mounting of the product must be completed by a professional installer. Improper installation may cause unsteadiness of the product.
- Do not put the product in a spot that may be exposed to mechanical vibration.
- Do not put the product in a spot where insects may enter.
- Do not place the product directly facing an air conditioner; otherwise condensation may form on the panel inside the display, resulting in a fault.
- Do not place the product near a strong electromagnetic field; otherwise it will be subjected to electromagnetic interference, and get damaged.

Ports

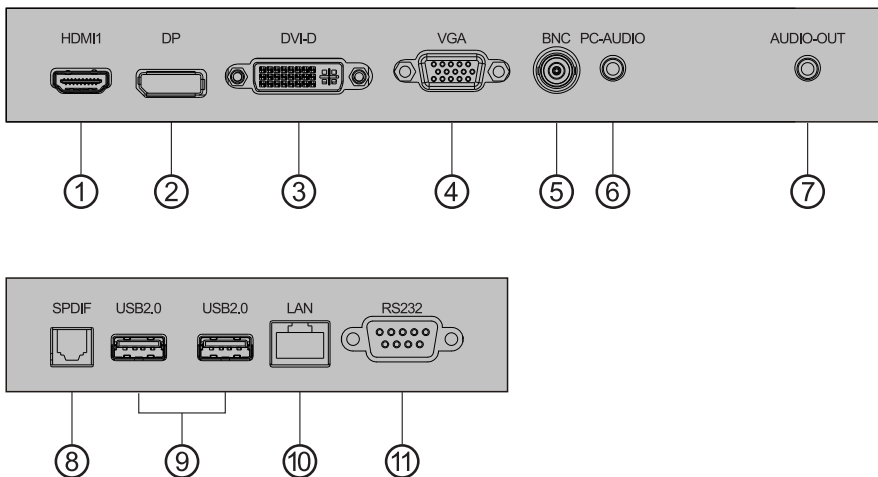

Note: Different models in the same series may have slightly different ports. The above pictures are subject to the actual product.

1. HDMI input; 2. DP input; 3. DVI-D input; 4. VGA input;
5. BNC input; 6. PC-AUDIO input; 7. AUDIO-OUT output;
8. SPDIF port; 9. USB2.0 port; 10. Network port; 11. RS232 port.

Caution: Disconnect the power plug before installing or removing the product!

Connection Diagram

Schematic diagram for connecting the product to a PC. (Note: Disconnect the power plug before installing or removing the product!)



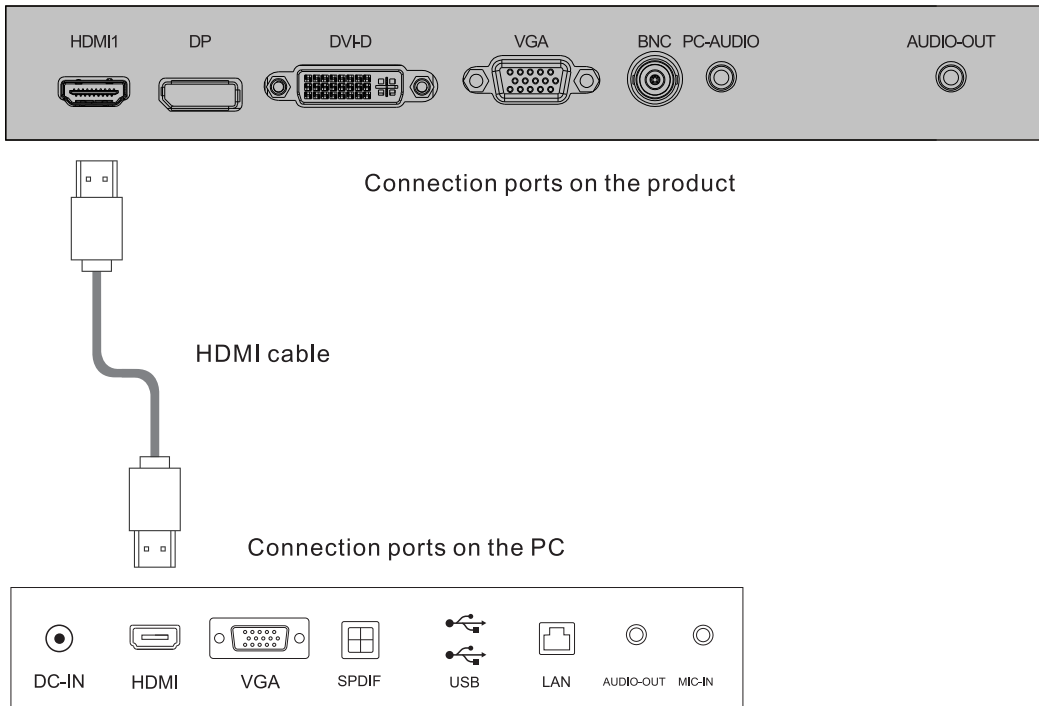





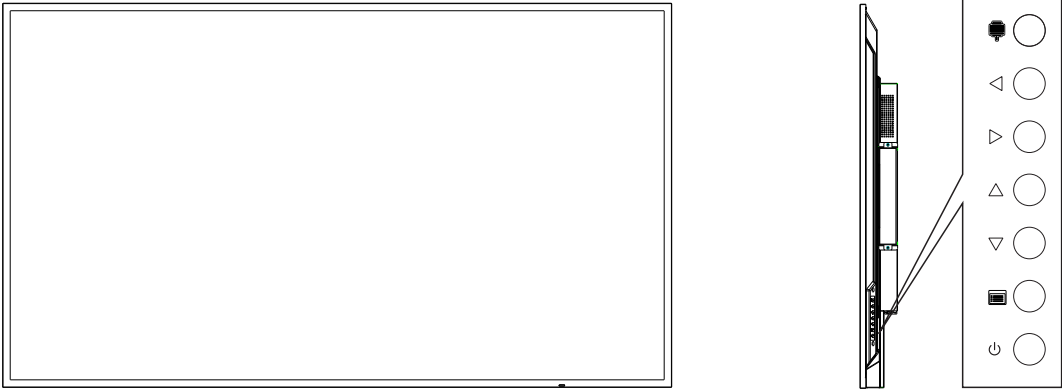





Connection diagram:



Note: The connection diagram in this Manual is only for reference when connecting to a PC, subject to the actual operations required.

Control Buttons on the Panel



1. Signal reception window for the remote control and the power indicator light.
2.  : press the  key to enter the Source menu, or to confirm your selection in the Settings menu.
3. / : press the / keys to select an item in a menu.
4. / : press the / keys to adjust the volume or the value of a selected item in the Settings menu.
5.  : press the  key to enter the Settings menu or to confirm your selection in the Source menu.
6.  : press the  key to turn the panel on or to switch to Standby mode.

Note: Different models may differ in appearance. The pictures above are subject to the actual product.

Remote Control

Install Batteries in the Remote Control:

Remove the battery compartment cover and install two AAA batteries (No.7, 1.5V) in accordance with the polarity marks “+” and “-”.

Precautions for Use of the Remote Control:

- Aim the remote control at the signal reception window on the panel when using the remote control. Any object placed between the remote control and the signal reception window may disrupt normal operation.
- Protect the remote control from strong vibrations. Never set or place the remote control in direct sunlight because the heat will lead to deformation of the remote control.
- When the signal reception window on the panel is subject to direct sunlight or strong light, the remote control may malfunction. In such case, please change the angle of the light or the angle of the panel, or operate the remote control closer to the signal reception window.

- Low battery voltage will affect the remote control distance. In such case, please replace the batteries with new ones. If the remote control is to be left unused for a long time or the batteries become depleted, please remove the batteries in order to avoid battery leakage, which may corrode and damage the remote control.
- Never use batteries of different types or mix a new battery with a used one. Always replace batteries in pairs.
- Never dispose of batteries in a fire, never recharge, short-circuit, disassemble/assemble, heat or burn any used batteries. Please dispose of waste batteries according to applicable environmental regulations. Do not expose batteries to a hot environment, such as direct sunlight, over the fire, etc.

Note: The actual appearance of the remote control may differ from the picture below.

Keys on the Remote Control



Key	Description
POWER (⏻)	Switch between normal operation and standby
SCREENSHOT (□)	Take screenshot
MUTE (🔇)	Enable or disable sound
LETTER/NUMERIC KEYS	Input any number
F1 (FREEZE)	Enable or disable freeze function
CH LIST (☰)	Allow backspace when inputting characters
HOME(🏠)	Display the home page of the product
MENU (☐)	Display the main Settings menu
CURSOR KEYS (⬅️/➡️/⬆️/⬇️)	Select or adjust menu options
VOL +/-	Adjust volume
BACK (↶)	Return to the previous setting interface
SOURCE	Display the source selection menu (valid only in TV mode)
CH +/-	No function
SOUND MODE	Select the sound mode of the product
SLEEP	Set the sleep time and auto standby when the specified time is reached
INFO	Display channel info of the product
ZOOM	Switch the channel display ratio on the screen
IMAGE	No function
SYS	No function
STEREO	No function
OK (OK)	Confirm the operation
PLAY (▶)	For operation of multimedia functions
PAUSE (⏸)	
STOP (■)	
ROTATE (🔄)	
PREV (⏮)	
NEXT (⏭)	
BACK (⏪)	
SPEED (⏩)	

Basic Operations

Power On/Standby

Insert the power plug into the power outlet. First switch on the On/Off switch “**Ⓢ**” on the panel, if available; then press “**Ⓢ**” key on the remote control or on the panel to turn it on. In the absence of the On/Off switch, just press “**Ⓢ**” key on the panel.

In power-on state, press “**Ⓢ**” key to switch the panel to standby.

No Signal Background

When no signal is available from the current input source, the No Signal Background will appear. The image for the No Signal Background can be modified in the Settings menu.

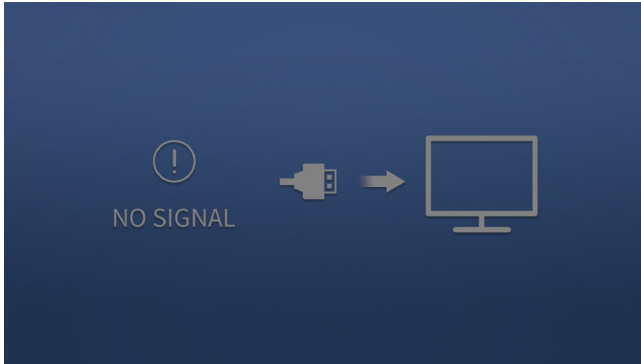

Source Selection

Press the "Source" key on the remote control or on the panel, the list of inputs will appear. Use “**▲/▼**” keys to select an input and press “**OK**” to confirm selection, the panel will then switch to the selected input source.

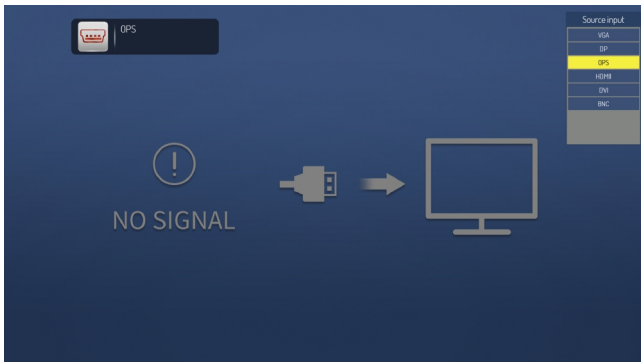

Settings Menu

This section illustrates standard panel operations, which may vary slightly depending on the state of the panel.

Press the "**Menu**" key on the remote control or on the panel, the Settings menu will appear. Then:

- (1) Press the "**◀/▶**" keys to select an item in the menu, which include Source, Image, Sound, Network, Options, Time, and About menus.
- (2) Press the "**▲/▼**" keys on the remote control to select an item in a submenu.
- (3) Press the "**OK**" key on the remote control to change the item settings.
- (4) Press the "**◀/▶**" keys on the remote control to adjust the item settings.
- (5) If the Settings menu is displayed on the screen, press the "**Menu**" key to exit the menu.
- (6) Items in gray colour are not available in the current state of the panel.

Source Menu

The Source menu has two submenus: Source and Source Lock.

Source: Select the source input from among VGA, DP, OPS, HDMI1, DVI, and BNC inputs.

Source Lock: When a source is locked, it is no longer available until unlocked.

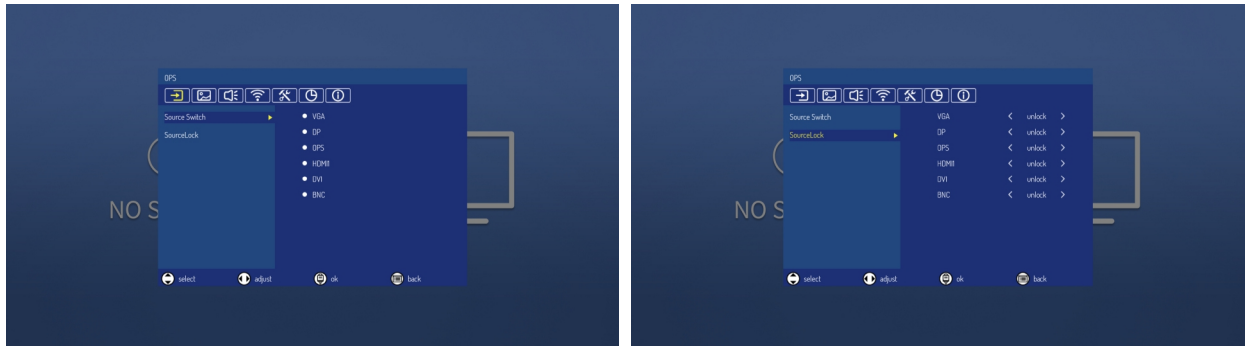

Image Menu

The Image menu has 5 submenus: Image, Color Temperature, Aspect Ratio, PC and Advanced settings.

Image: Select the image mode - PC, Eye Pro, Standard, Soft, Bright and User (these options may vary depending on the input source).

Color Temperature: Select the color temperature of the image: cold, warm and standard.

Aspect Ratio: Select the aspect ratio: 16:9, 4:3 and Dot by Dot.

PC: Automatic picture correction - horizontal, vertical, phase and clock (only available for VGA source).

Advanced Settings: Adjust the panel's display settings - backlight, color range, GAMMA, HDR and HDMI EDID.

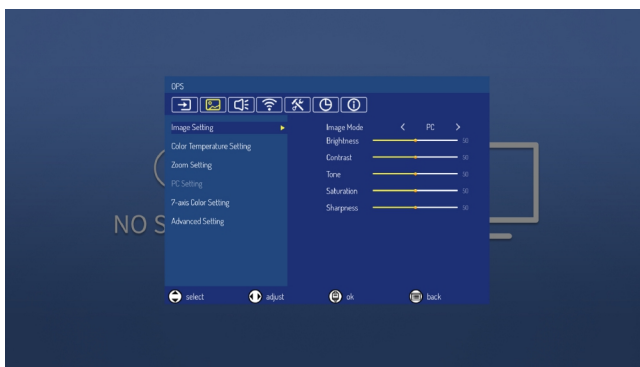

Sound Menu

The Sound menu has 5 submenus: Volume, Balance, Equalizer, Sound Output and Audio Only.

Volume: Mute or set the volume (0-100).

Balance: Adjust the balance between the left and right audio channels (L50-R50, default 0).

Equalizer: Adjust the treble and bass (0-100).

Sound Output: Select the built-in device or an external device to output the sound.

Audio Only: Turn off the screen and play the audio only.

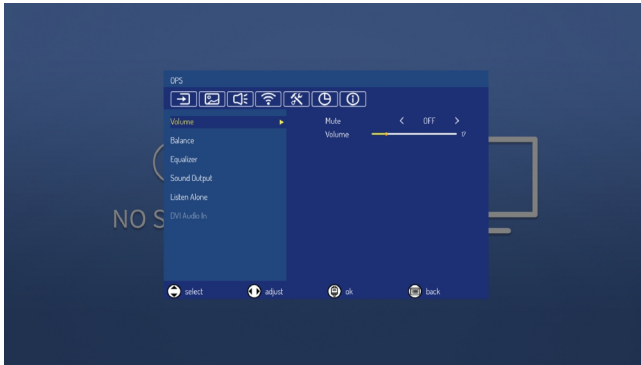

Network Menu

The Network menu has 3 submenus: WiFi, Ethernet and Hotspot.

WiFi: Turn the WiFi on and then select the WiFi network you wish to connect to.

Ethernet: Connect a network cable to the panel and then configure the network connection to access the wired network.

Hotspot: Turn the WiFi hotspot on and then other devices can connect to the Internet through the panel's hotspot.

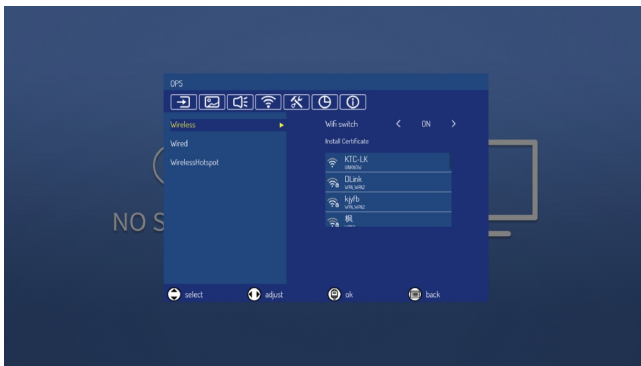

Options Menu

The Options menu has the following submenus: Language, USB Media, Wallpaper and Display, Control, Power Settings, Remote / Keypad Lock, Application Management, System Update and Reset.

Language: Set the language.

USB Media: Set the mode and duration for USB media playback.

Wallpaper and Display: Set the wallpaper no signal screen image and protection.

Control: Enable/Disable RS232 serial communication and HDMI CEC.

Power Settings: Enable/Disable Wake On LAN and set the period of time without signal that triggers automatic shutdown.

Remote Control and Keypad Lock: Disable the remote control or panel keys.

Application Management: Display application information.

System Update: Update the panel's system.

Reset: Delete all custom settings and restore the panel's system to the factory settings.

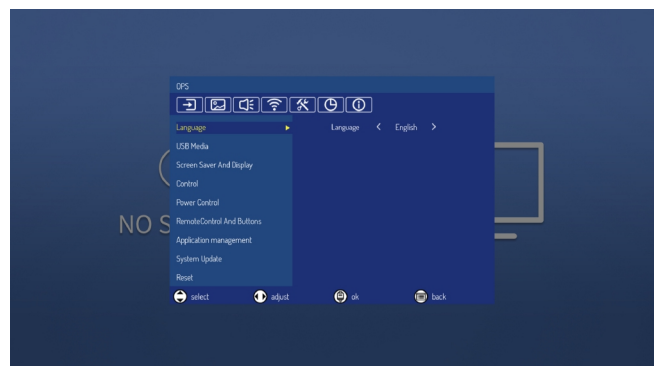

Time Menu

The Time menu has 2 submenus: Time and Date, and Schedule Power Off.

Time and Date: Set the time and date.

Schedule Power Off: Schedule the panel power off time.

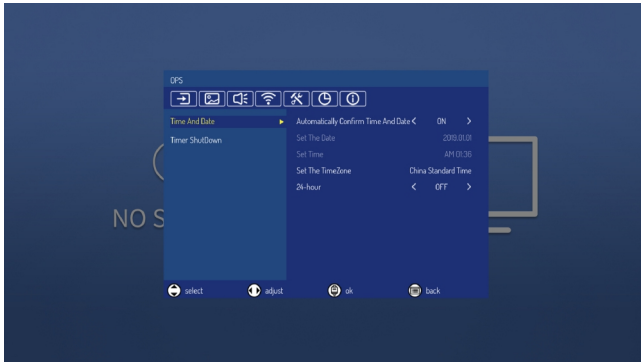

About Menu

The About menu has 3 submenus: Source Information, Monitor Information, and System Information.

Source Information: Displays information about the current input source.

Monitor Information: Displays the panel's serial number and running time.

System Information: Displays the panel's system information.

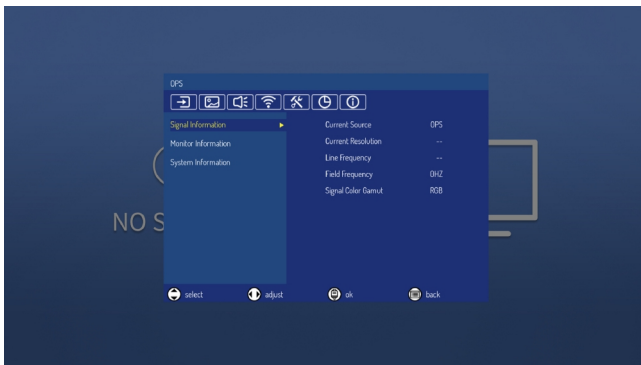

Instructions

Basic Android Operations

Press the “**▲**” key on the remote control to display the home screen (as shown in the figure).

1. Press the “**◀/▶/▲/▼**” keys to select an application;
2. Press the “**OK**” key to run the application;
3. Press the “**Back**” key to return to the previous screen.

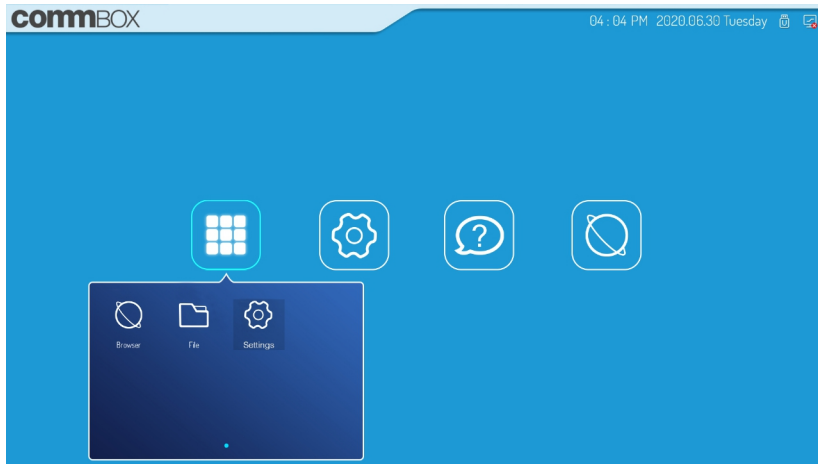

Note:

The operations described in this manual are for reference only. Users can install applications of their choosing and the resulting operations will vary depending on the applications installed. Some app operations may not be possible via the remote control. For a more convenient operation, a mouse and a keyboard can be connected to the panel via USB.

How to use the mouse: 1. Left click: click the left mouse button and release it immediately. This is the same as pressing the “OK” button on the remote control. 2. Long press: press and hold the left button for more than 3s and then release it. 3. Right click: click the right mouse button and release it immediately. This has the same effect as pressing the “Back” button on the remote control.

File App

The File app allows navigating through files and folders, as well as playing music and videos from external devices such as USB flash drives. To open a file from a USB flash drive, connect the drive to the panel’s USB port and select the File app on the home screen. Select the USB flash drive in the list on the left, and then the folder and file on the right to play it.

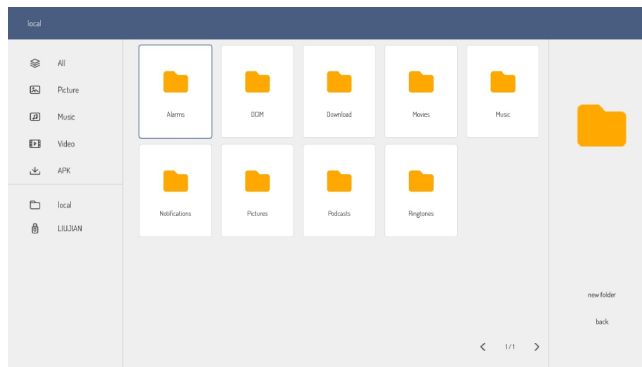

Note:

- ① Please use standard USB devices as non-standard devices may not be supported.
- ② The streaming media system may not support all file formats. An error will occur when playing unsupported file formats.
- ③ Please do not plug or unplug a USB device during playback, as this may cause system or device error.
- ④ USB flash drives and mobile hard disk drives complying with USB1.1 and USB2.0 protocols are supported.
- ⑤ The max output current of the USB port is 500mA. An external power supply is recommended for devices that require larger current.
- ⑥ When reading or playing files, the screen may freeze and some functions may not work due to compatibility or stability issues with the USB device. If this occurs, please restart the panel.

Important Statement on Network Service

All contents and services obtained through the product are owned by third parties and protected by copyright, patent, trademark and/or other intellectual property laws. These contents and services are only for your personal non-commercial purposes, which shall not be used in a way not authorized by the content owner or service provider.

Under no circumstance shall our Company be liable for any direct, indirect or unexpected losses or damages arising from your or any third party's access to any contents or services or any information or third-party software through this product.

Third-party services may be subject to change, removal or discontinuation without prior notice. Our Company does not represent or warrant that some services or contents will remain accessible at any time.

Our Company will not be responsible for any service related to these contents and services, or assume any liability for customer service. For any question or service request about these contents and services, please directly contact your content or service provider.

Troubleshooting

Symptom	Possible Cause	Solution
The screen does not display anything; there is no sound, and the power indicator does not turn on	The power cord is not plugged in properly, power connection failure	Check if the power cord is connected properly
Images displayed on the screen have dotted lines or striped interference	Signal interference caused by cars, neon lights, electric hair dryer, etc.	Do not use an electric hair dryer near the product
Images displayed on the PC are offset, do not cover the entire screen, go beyond the screen, or are blurred	<ol style="list-style-type: none"> 1. Improper adjustment 2. Wrong display mode 	<ol style="list-style-type: none"> 1. Use the auto adjustment function 2. Enter "PC Screen Adjustment" to adjust the horizontal or vertical position 3. Use the recommended mode
Short remote control distance, malfunctioning of remote control	<ol style="list-style-type: none"> 1. The remote receiver of the product is blocked by an object 2. Remote control battery charge is low 	<ol style="list-style-type: none"> 1. Move the object to avoid blocking the signal receiving window on the panel 2. Replace the batteries
The panel freezes, crashes or cannot be operated	<ol style="list-style-type: none"> 1. Too many applications are running 2. Normal operation of the product is disturbed by external environment (e.g., lightning, static electricity) 	Disconnect the panel from power supply; wait for 1-2min and reconnect power supply; then restart the panel
OPS cannot be turned on, nothing displayed	OPS has not been installed properly	Install the OPS computer properly

Toxic/Hazardous Substances/Elements in the Product

Component	Toxic and Hazardous Substance or Element					
	(Pb)	(Hg)	(Cd)	(Cr ⁶⁺)	(PBB)	(PBDE)
Displayscreen	x	○	○	○	○	○
Housing	○	○	○	○	○	○
PCBA*	x	○	○	○	○	○
Power cord and cables	x	○	○	○	○	○
Metal parts	○	○	○	○	○	○
Packing materials*	○	○	○	○	○	○
Remote control	x	○	○	○	○	○
Speaker	x	○	○	○	○	○
Accessories*	○	○	○	○	○	○

This table has been prepared in accordance with SJ/T11364.

*: PCBA includes the PCB and its electronic components;

Packing materials include the carton, EPS, etc.

Other accessories include the User Manual, etc.

○: The content of such toxic/hazardous substance in all homogeneous materials of such component falls within the content limit specified in GB/T26572-2011.

×: The content of such toxic/hazardous substance in one or more homogeneous materials of such component goes beyond the content limit specified in GB/T26572-2011.

As shown in the above table prepared based on the data provided by our material suppliers for each type of materials and verified by us, this product contains hazardous substances. The hazardous substances contained in some materials are irreplaceable at the current technological level although we have been trying to improve this.



The environmentally-friendly use period of this product is 10 years (see the pollution control symbol on the right).

Such use period will be maintained under the normal working conditions specified in the User Manual.

Indicative Description of Regulations on Recycling and Disposal of Waste Electrical and Electronic Products.

When you no longer need this product, or at the end of its service life, please send it to a local recycling facility with nationally recognized qualifications for recycling according to the applicable national laws and regulations on recycling waste electrical and electronic products.



The terms HDMI and HDMI High-Definition Multimedia Interface, and the HDMI Logo are trademarks or registered trademarks of HDMI Licensing Administrator, Inc. in the United States and other countries.

Notes

Notes

commBOX.com.au

p: +61 2 9975 6001 | e: office@commbox.com.au